

RM-47 FET Component Kit.

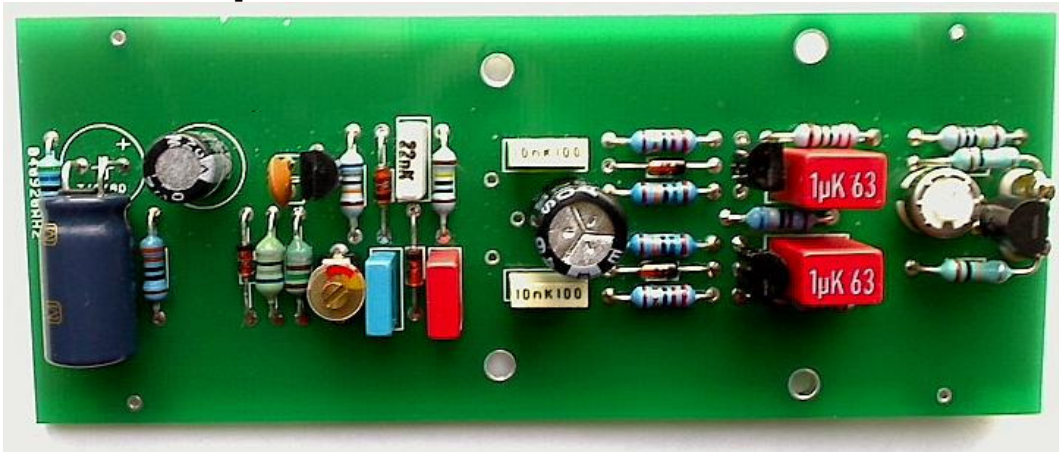

Resistors:

2 x 22 Ohms	Red/Red/Black/Gold/Brown
1 x 330 Ohms	Orange/Orange/Black/Black/Brown
1 x 560 Ohms	Green/Blue/Black/Black/Brown
2 x 2.2 K.Ohms	Red/Red/Black/Brown/Brown
1 x 6.8 K.Ohms	Blue/Gray/Black/Brown/Brown
2 x 150 K.Ohms	Brown/Green/Black/Orange/Brown
1 x 680 K.Ohms	Blue/Gray/Black/Orange/Brown
2 x 1 M.Ohms	Brown/Black/Black/Yellow/Brown
2 x 1 G.Ohms	Brown/Black/Gray/Silver
1 x Trimpot, 500 K.Ohms	White/metal round component with 3 wires

Capacitors:

1 x Trimmer capacitor 30 pF	Green, with two pins 5 mm apart
1 x 27 pF Ceramic	Brown with two wires 2.5 mm apart, 27
1 x 1 nF Styroflex	Silver capacitor with wires at the end, 1000
1 x 1 nF	Blue capacitor with wires 5 mm. Apart, 1 nK 63
2 x 10 nF	White capacitor with wires 5 mm apart, 10nK 100
1 x 22 nF	White or gray capacitor with wires 5 mm apart, 22nK
1 x 220 nF	Red or blue capacitor, wires 5 mm apart, 0,22 63
2 x 1 μ F	White or blue capacitor, wires 5 mm apart, 1 μ K63 (1K63)
1 x 47 μ F	47 μ F/50 V.
1 x 220 μ F	220 μ F/10 V.
1 x 470 μ F	470 μ F/10 or 16 V.

Semiconductors:

2 x Diode 1N4148 or 1N4448	Glass, 4148 or 4448
2 x Zener diode, 6.2 V.	Glass, 6.2
1 x Zener diode, 6.8 V.	Glass, 6.8
1 x Zener diode, 7.5 V.	Glass, 7.5
1 x 2SK170BL, Field Effect Transistor	
1 x BC547 B, NPN transistor	
2 x BC557 B, PNP transistor (selected and hand matched!)	

Miscellaneous:

1 x Printed circuit board with solder mask and silkscreen, M-12	
2 x Teflon feedthrough (Already mounted on the Printed Circuit Board)	
1 x Coil, 68 μ H	Resistor shaped, Blue/Gray/Black/Silver
1 x Coil, 150 μ H	Resistor shaped, Brown/Green/Brown/Silver

1 - Introduction

The RM-47 FET kit offers a high quality capsule amplifier circuit for your microphone. Only high quality components are used: 1% low noise metal film resistors, Wima and Panasonic capacitors, Styroflex capsule coupling capacitor etc.

Some components are carefully hand selected and matched to get the highest quality. The circuit provides a very 'clean' signal. Because no transformer is used, the audio quality is not degraded by the effects of the core material in the transformer.

Distortion of the circuit, when properly aligned, is even below 0.02% at high levels!

Also the self noise is extremely low, one of the primary requirements in the digital era we live in.

Construction is relatively easy, especially if you have some experience with the construction of electronic circuits.

The printed circuit board has a solder mask and is pre-tinned, to make soldering even easier. The only thing you have to take care of, is the placement of the components. This is described below. Not very much can go wrong!

The finalized circuit board has adjustments for the polarisation voltage on the capsule, and a trimmer to set the FET bias, for lowest possible distortion and maximum headroom.

Warning: Don't use other components than the components provided.

The PNP transistors for example are hand selected and matched for V_{be} , H_{fe} and noise. If you replace them with other transistors, there is no guarantee that the results will be good. The transistors themselves are very common and cheap types, but what makes these transistors so special, is that they were hand selected from a large quantity of transistors to meet the highest specifications. From 100 transistors in general only 10 pairs meet the strict requirements. So, as long as you use the materials in the supplied plastic bags, nothing can go wrong!

2 - Assembly:

It may be a good idea to check first if the printed circuit board fits the microphone body. If not, it is no problem to use a file or a piece of sandpaper to make the board a little bit smaller, so it will fit.

Usually this is not necessary, but it will be much harder to adjust the size of the printed circuit board when all components are mounted.

If you are sure the PCB fits, we are ready to go!

First we place and solder two 22 Ohms resistors.

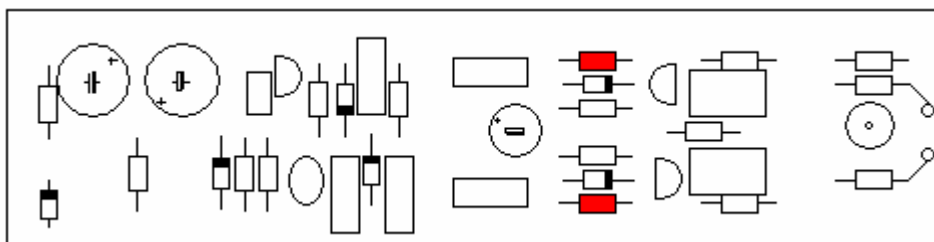

The components we have to place are marked with a red color. During the next step, the components already on the board will be displayed with a gray color.

Next we place the two 150 K.Ohms resistors:

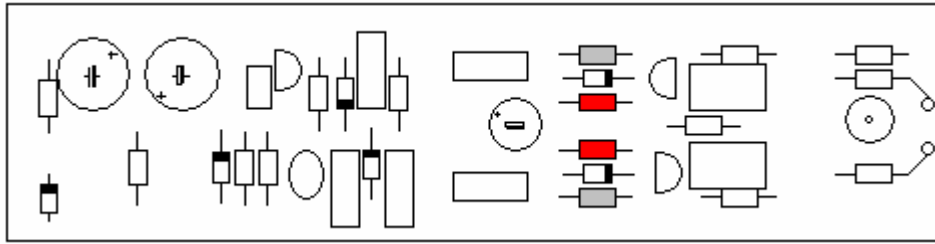

To following step is to place the 6.8 K.Ohms resistor:

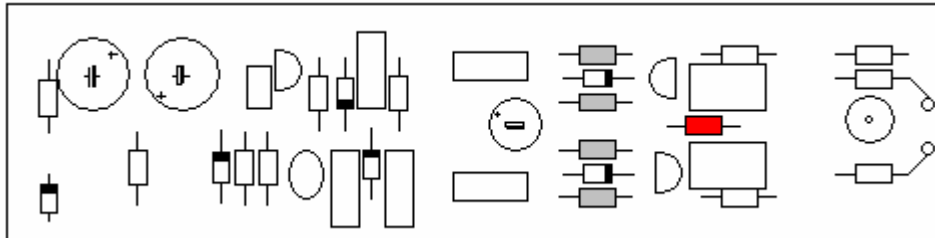

Now we place the two 2.2 K.Ohms resistors:

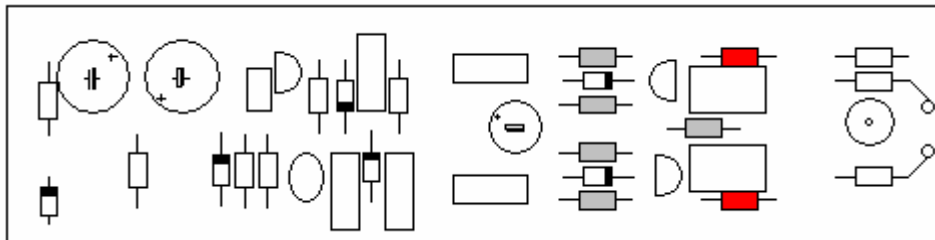

Next we place the two 1 M.Ohms resistors:

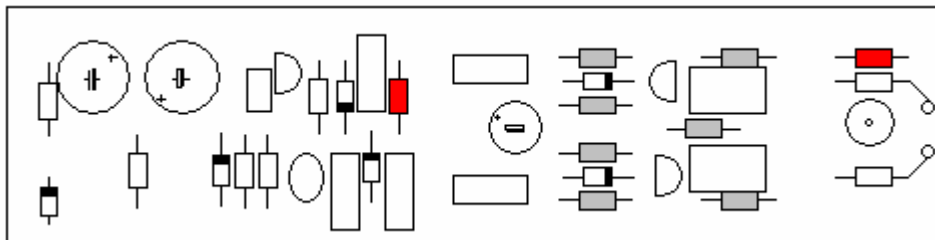

The 330 Ohms resistor goes here:

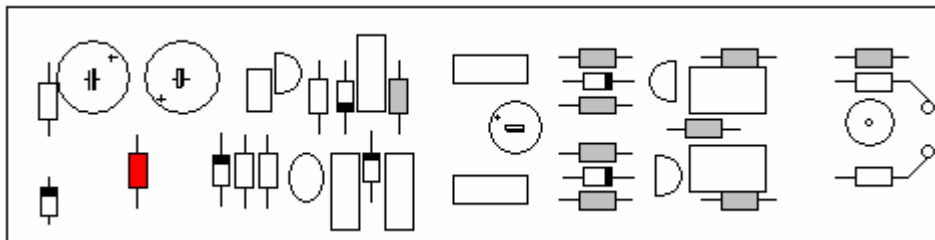

Insert the 680 K.Ohms resistor in this position

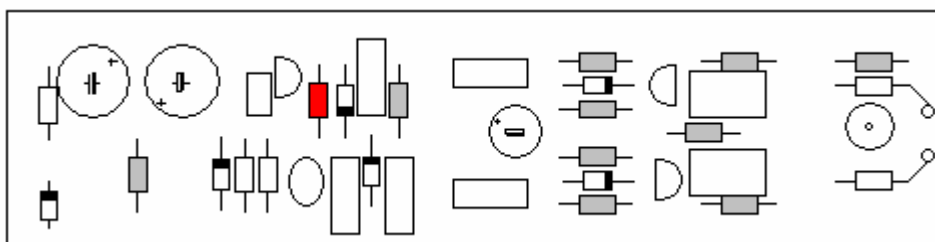

Now we take the 68 μH inductor and place it here

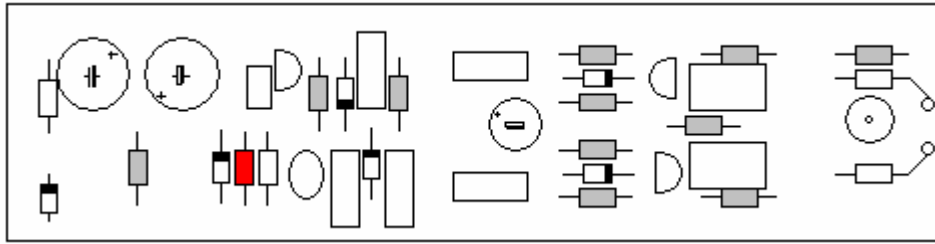

The 150 μH inductor goes next to the previous one:

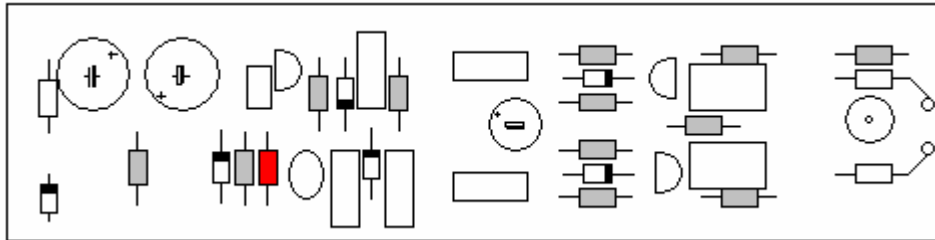

Not all resistors are mounted now, but there is a reason for this.

Next we mount the 30 pF trimmer capacitor. The orientation is not important here.

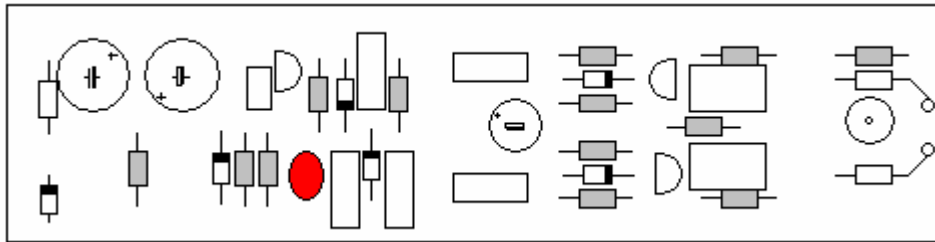

Now we take the cermet trimmer potentiometer and take a closer look at it.

The wires are placed in the form of a triangle. Two wires are further apart than the others. Take care that you insert the trimmer potentiometer in such a way, that the arrangement of the wires matches the holes in the PCB.

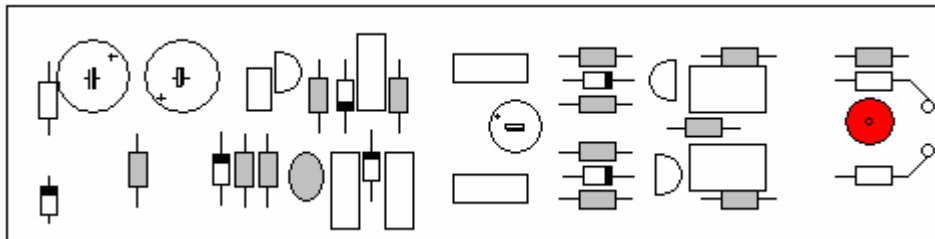

Almost half way already!

Now we are going to mount some semiconductors; the diodes and transistors. Two 1N4148 diodes go here:

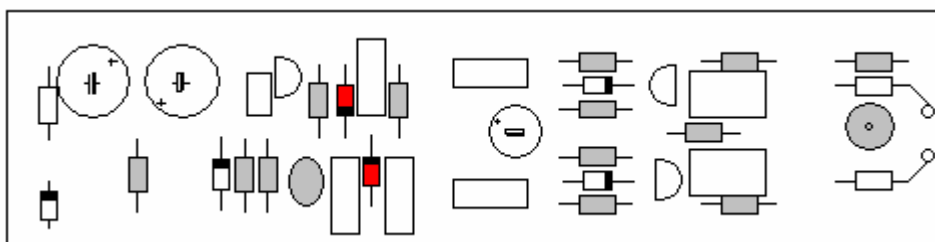

Take care that the black ring on the diode matches the white line on the PCB!

The next step is to place the 6.2 V. zener diodes. Also here, take care of the orientation!

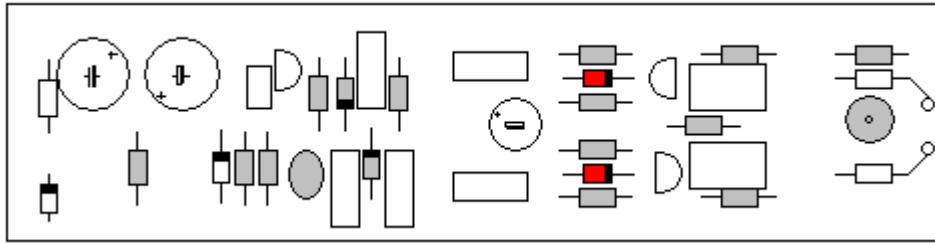

Next we put in the 7.5 V. Zener diode. Watch the orientation!

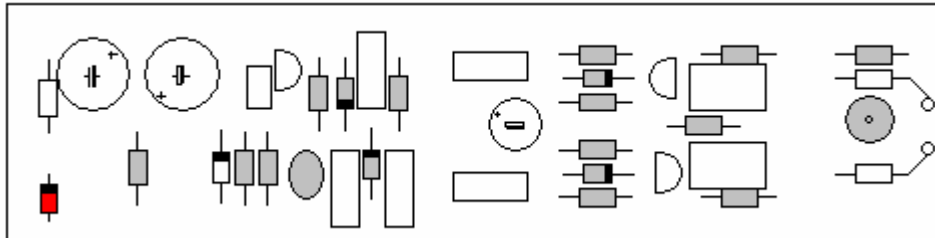

The last diode we place is the 6.8 V. Zener diode. Same procedure as with the others.

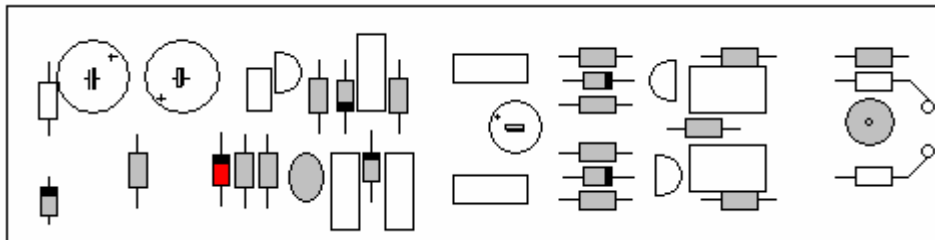

Now we place the BC547B transistor. The wires are in a triangle that fits the hole pattern in the PCB:

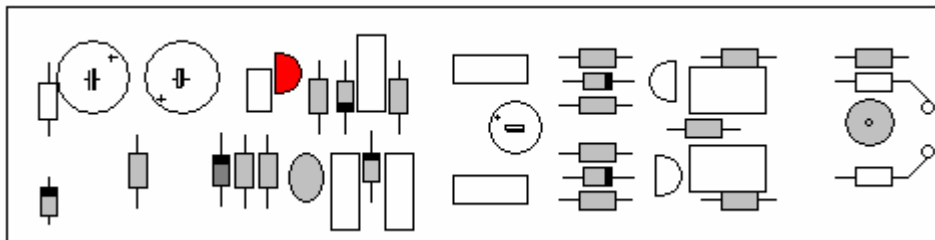

Now we put in the two BC557B transistors. The holes are on a single row now. Observe how the transistors should be placed, the flat side is on the right side for the upper one, and on the left side for the lower one.

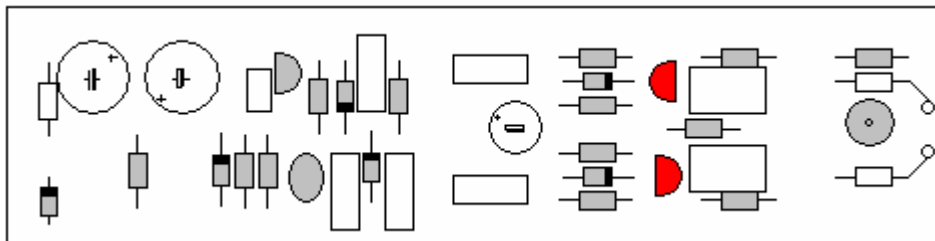

OK, we are getting there! Now it is time for the capacitors.

Place the two 1 μF capacitors here:

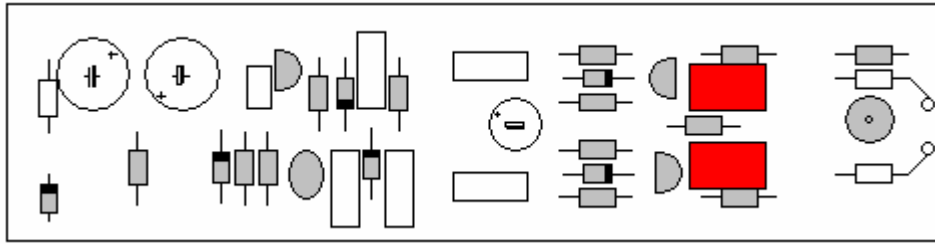

Next we put the two 10 nF capacitors here:

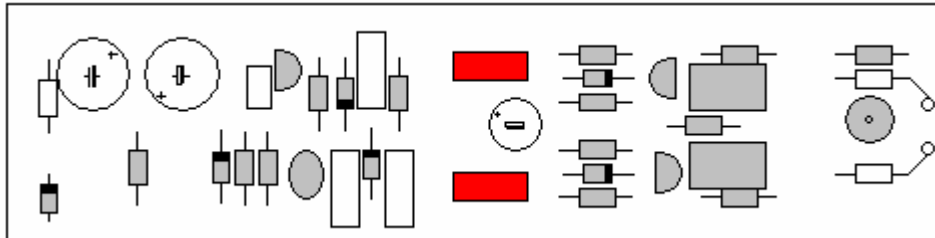

The small 27 pF capacitor goes here:

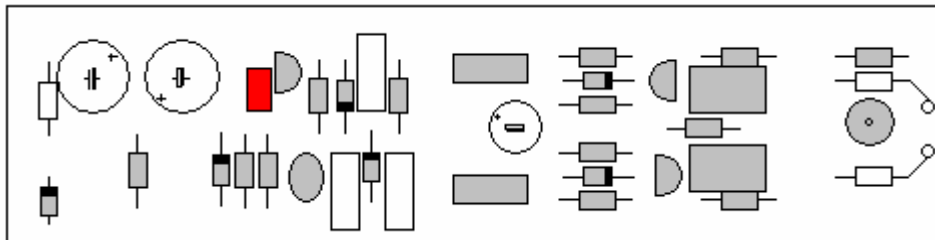

The next step is to put the 1 nF capacitor here:

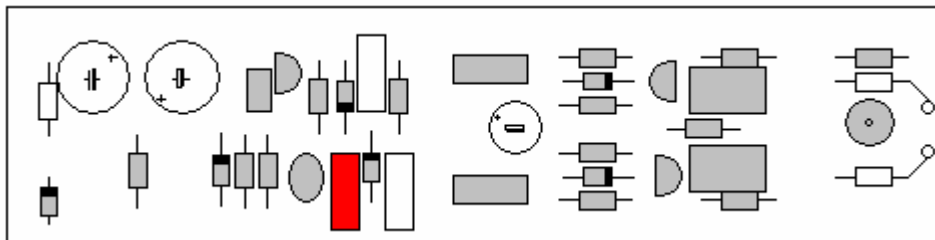

The 22 nF capacitor goes here:

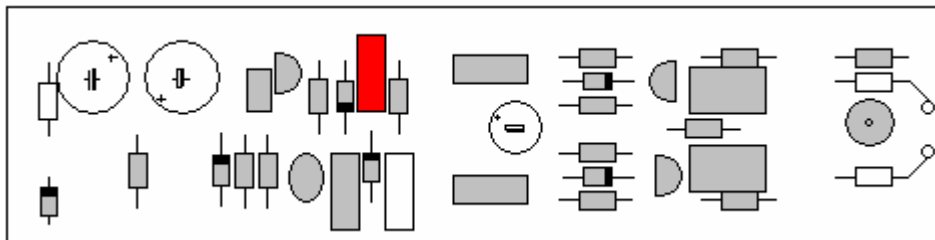

And the 220 nF capacitor goes here:

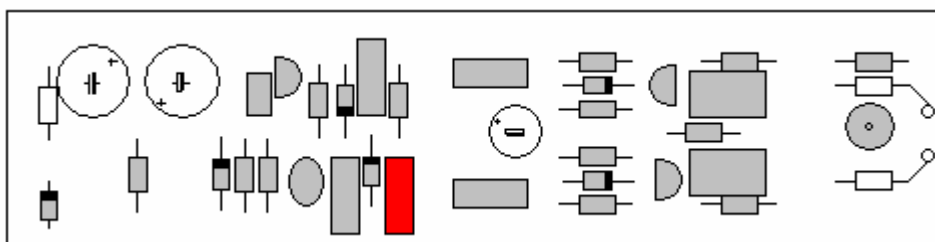

It is already getting pretty crowded!

Still a couple of electrolytic capacitors to go before we can start our first tests!

The next step is to place the 470 μF capacitor.

This component is too high, so we have to bend the wires and put it flat on the PCB. Like this.

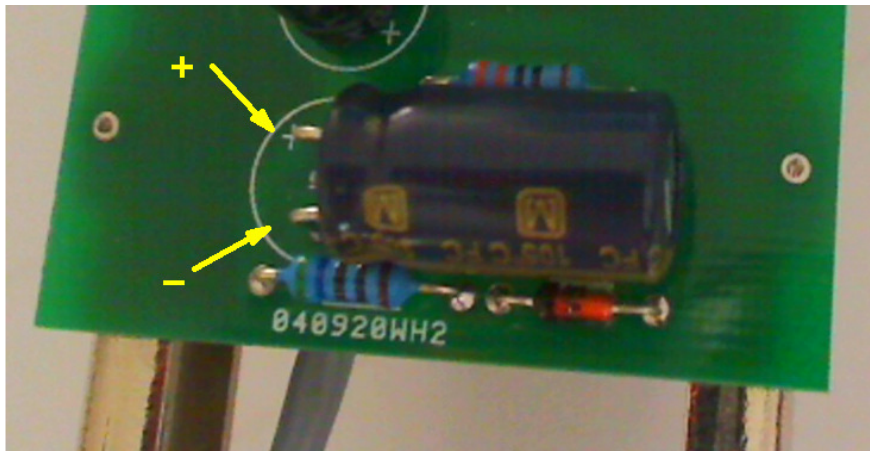

Observe the polarity!

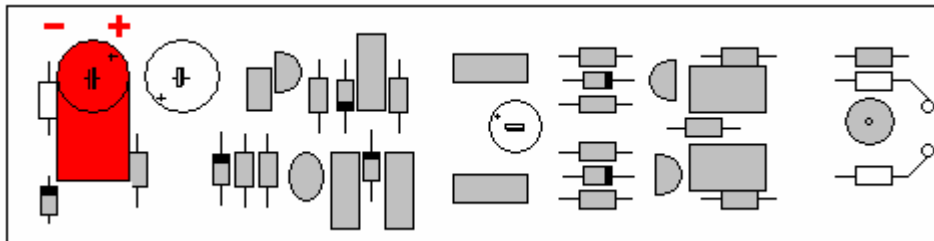

Next we put in the 220 μF . Also here, polarity is important!

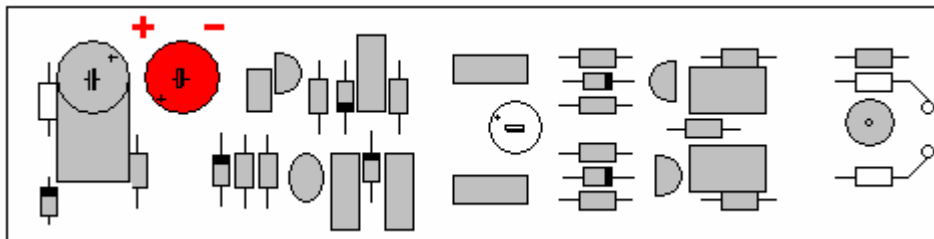

And the last capacitor we are going to add, is the 47 μF :

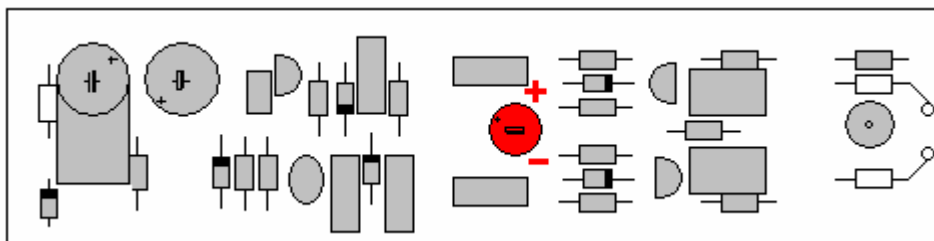

OK, time to do the first test!

To do this, we have to make two temporary connections to the PCB.

This is the bottom side, with the tracks:

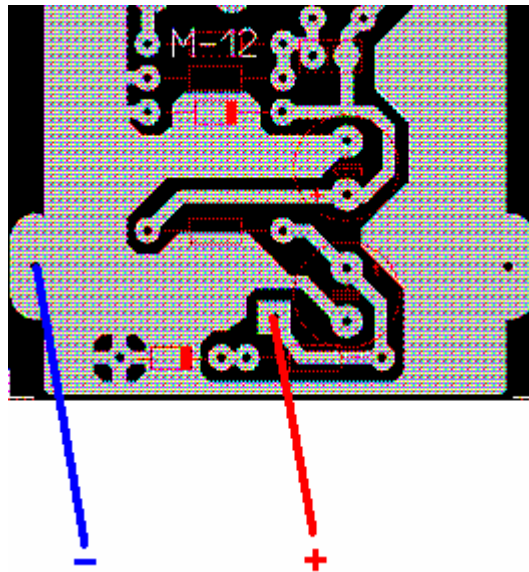

First turn the 30 pF trimmer capacitor a bit counterclockwise, so that the rotor blades are half covered by the stator blades. This is a good starting point.

In the newer kits, we use a green trimmer, that does not show the rotor blades. If your kit has a green trimmer, use a small screwdriver and rotate the trimmer 90 degrees counterclockwise.

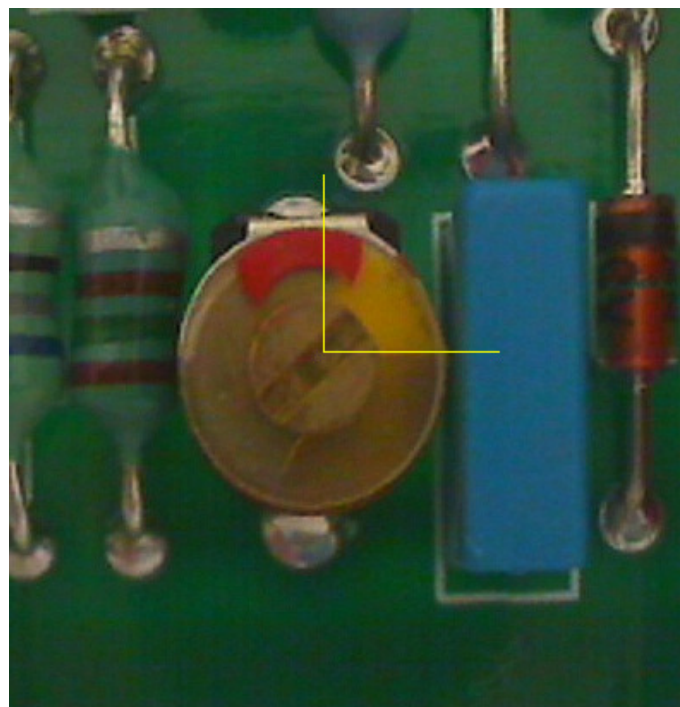

Now connect the two wires that you have just attached to the PCB to a voltage between 7.5 and 9 Volts. This can be a power supply, or a 9 Volts battery.
 Check the voltage at the output of the DC converter with a voltmeter.
 You should get something between 50 and 60 Volts.
 The points where you measure the voltage are here:

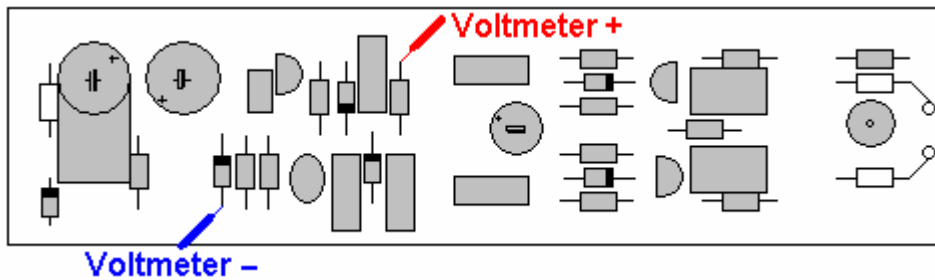

If the voltage is lower than 60 Volts, turn the trimmer capacitor so that the rotor blades are more between the stator blades. (=Clockwise)
 You will notice that the voltage changes when you touch the trimmer capacitor, this is normal! If you don't have a special isolated trimmer tool, you can use a small strip of a plastic credit card to turn the trimmer. In this way you don't influence the voltage reading.
 If the voltage is higher than 60 Volts, turn the trimmer so that the rotor blades are *less* covered by the stator blades. (=Counterclockwise)
 60 Volts is fine, don't go higher than 60 Volts, because this could damage the microphone capsule in a later stage. By the way: the voltage is not very critical. In fact every value between 55 and 60 Volts is fine. (The difference in output will be less than 1 dB at 55 Volts.) Did you adjust the voltage correctly? Congratulations!
 We can now complete the audio part of the PCB!

Mount the 560 Ohms resistor here:

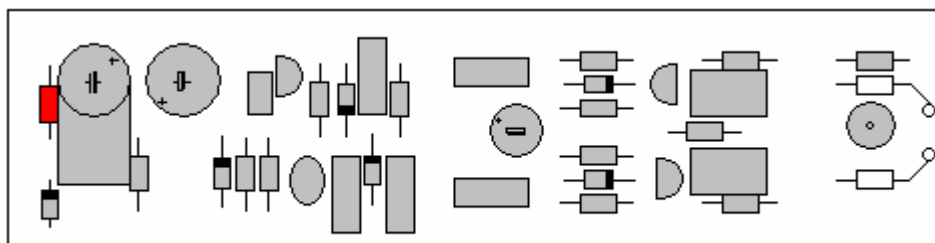

Now we take the two 1 G.Ohms resistors.
 Those components form the extremely high input impedance of our microphone circuit. In fact, we are dealing with 1.000.000.000 Ohms!
 For this reason we don't push the resistors down so that they touch the PCB, but we mount them just a bit higher, so that they are 'floating' in the air.
 One 'leg' of each resistor goes with a 90 degrees angle into the PCB, but on the other 'leg' goes with a 90 degrees angle in the opening of the teflon feedthrough.
IMPORTANT: Don't solder the wires going to the teflon feedthroughs yet!

If you did everything like it should, it should look more or less like this:
(Photo was taken from a completed microphone!)

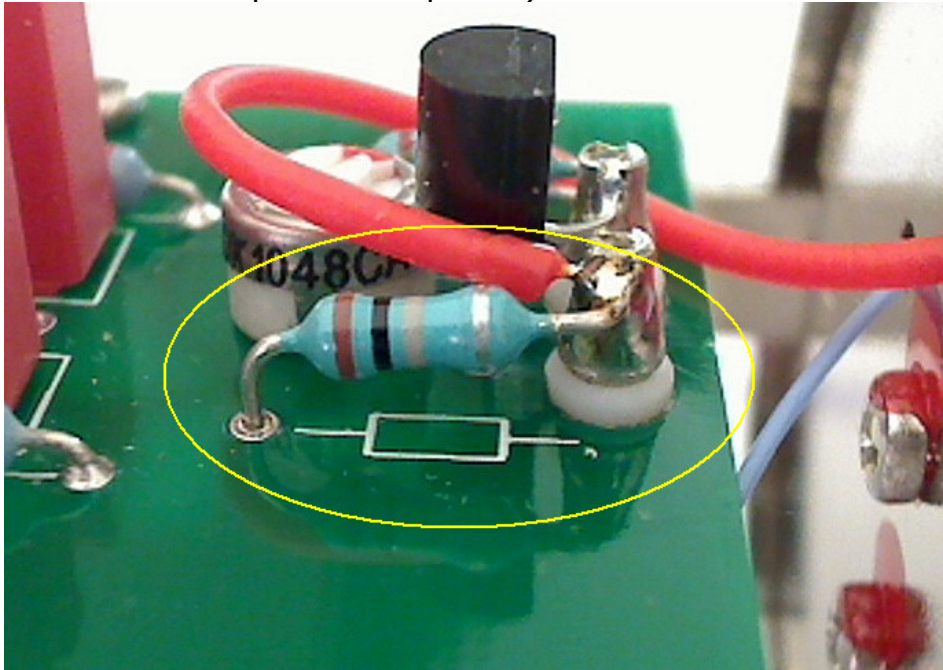

Next, we install the FET. First we bend the wire in the middle outwards, under an angle of about 90 degrees in the direction of the flat side of the black body.

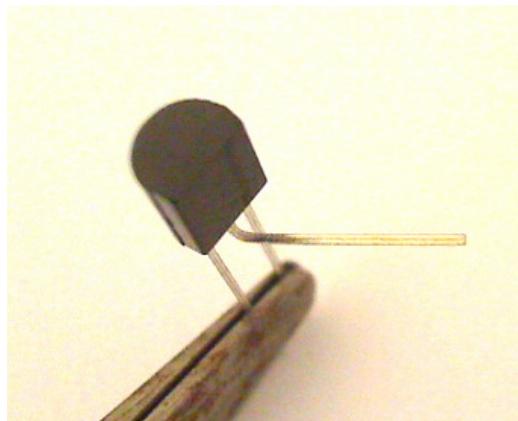

Now we insert the FET in the two holes near the small edge of the PCB and solder it into the circuit. The leg that we have just have bent, goes to the teflon feedthrough:

DON'T solder the wire to the teflon feedthrough yet!

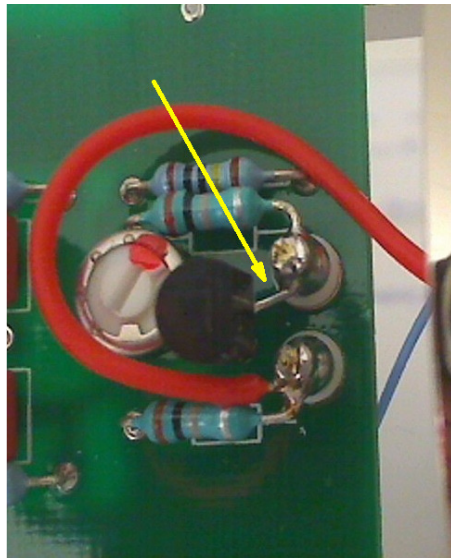

Now we take the 1 nF styroflex capacitor and fold the two wires close to the body of the capacitor, like this.

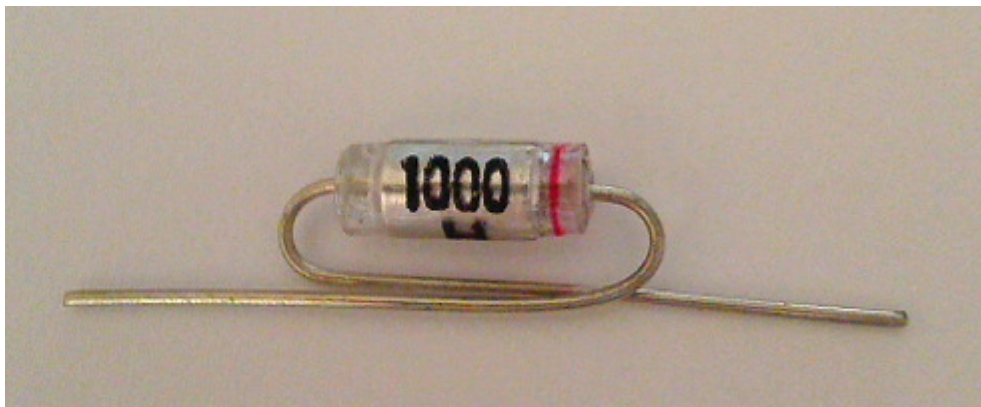

Then bend the wires of the styroflex capacitor under an angle of 90 degrees and cut the wires to length.

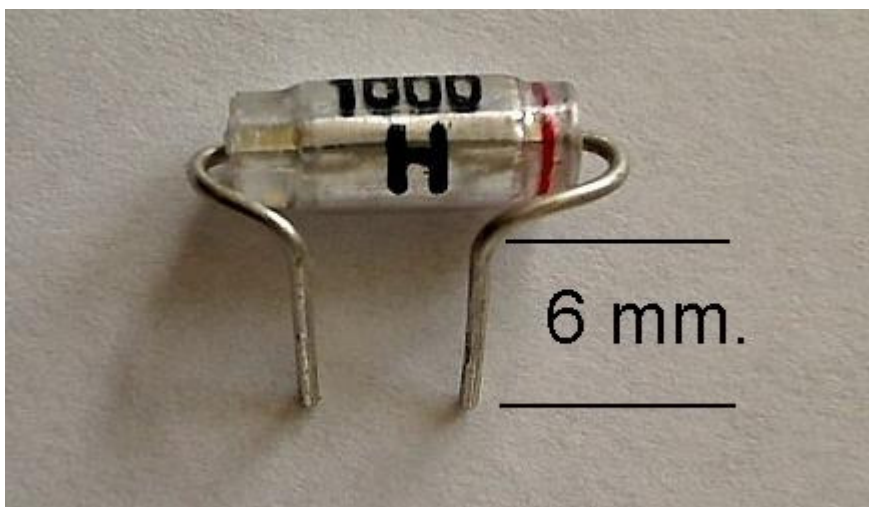

Insert the wires of the styroflex capacitor in the holes of the teflon feedthroughs from the trace side of the PCB. The length is correct if the wires of the 1 G.ohm resistors on the component side are just touched. Now solder all wires connected to the teflon feedthroughs.

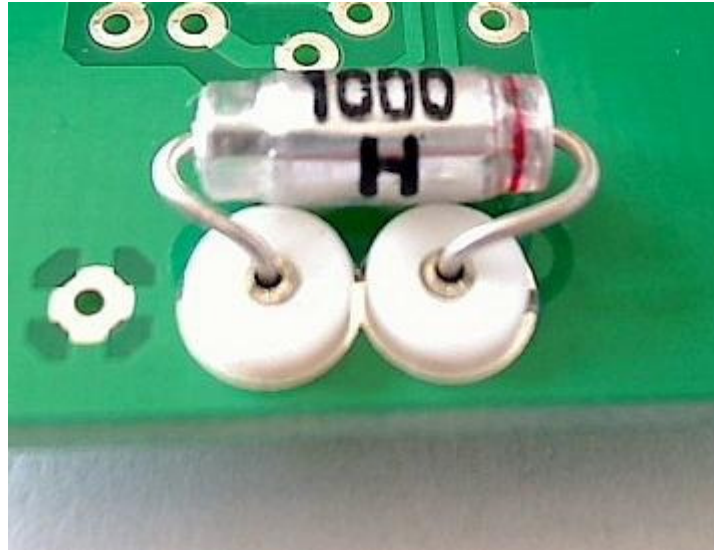

The styroflex capacitors are sensitive to overheating. It might be a good idea to place an alligator clip on the wire of the capacitor close to the capacitor body while soldering. This way the heat is absorbed.

It is a good idea to remove the solder flux from the teflon feedthroughs afterwards with alcohol and clean the 1 G.ohms resistors to avoid small leak currents.

We are near the end now! But first we have to connect the audio part to the DC converter part on the backside of the PCB, like this:

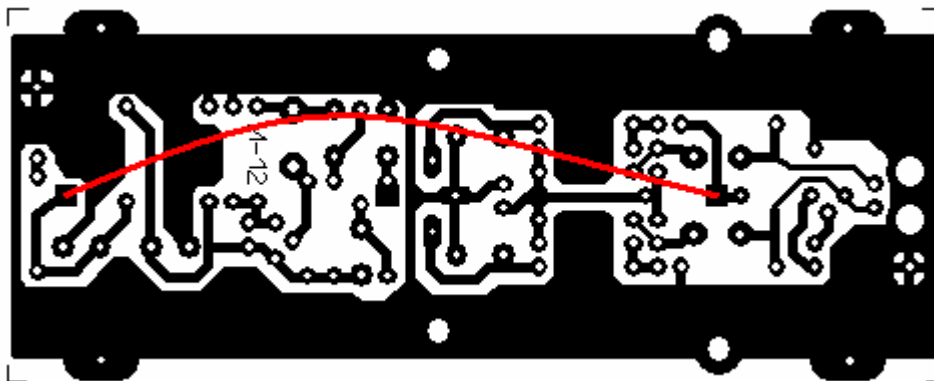

The wire should make a connection between the two square pads. Don't forget this, otherwise the microphone won't work!

Now it is time to adjust the audio part.

Connect the printed circuit board to a XLR-3 connector, and connect the circuit with a cable to a mixer or a soundcard that can deliver 48 V phantom power.

The XLR connections should be like this:

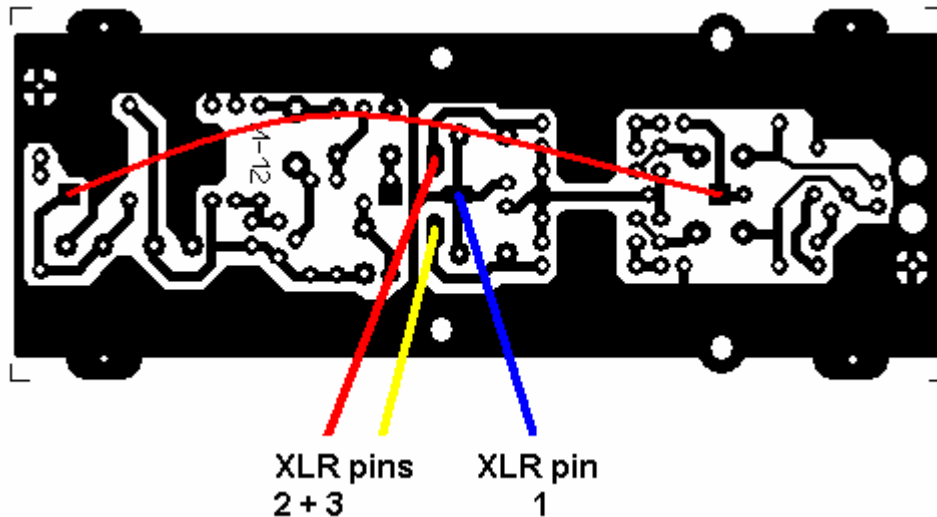

Turn the gain of the input to a minimum, because we will get a loud hum!
 This is because the circuit is not screened yet, and because of the high input impedance of the circuit, the input connection will act as an antenna, receiving all AC signals that are 'in the air'.

Well, phantom power turned on and no smoke? Good!
 Now we have to adjust the FET bias. To do this, we need a voltmeter again.

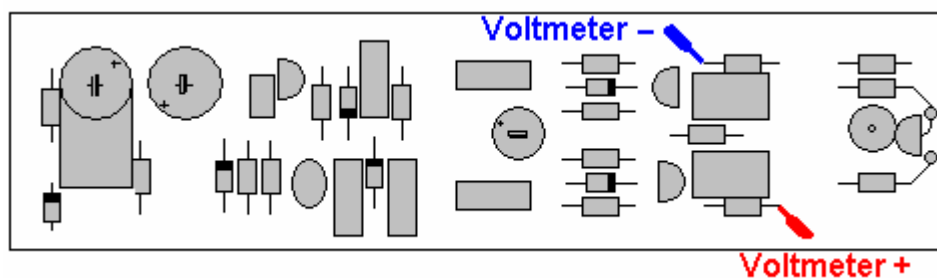

Adjust the cermet trimmer potentiometer for a voltage of 5.25 Volts.
 This is a good compromise if you don't have an oscilloscope or a distortion analyser.
 There is no need to adjust the cermet potentiometer for *exactly* 5.25 Volts. Normally a value between 5.2 and 5.3 Volts is fine. Notice that the voltage rises or falls **slowly**. Take some time to let the voltage stabilize and make small corrections at a time.
 After you reached the right value, leave the circuit on for a couple of minutes and check the voltage again. Correct the cermet potentiometer if the voltage has changed too much.

If you do own an oscilloscope, connect a tone generator to the input (and ground, this is pin 1 of the XLR connector)

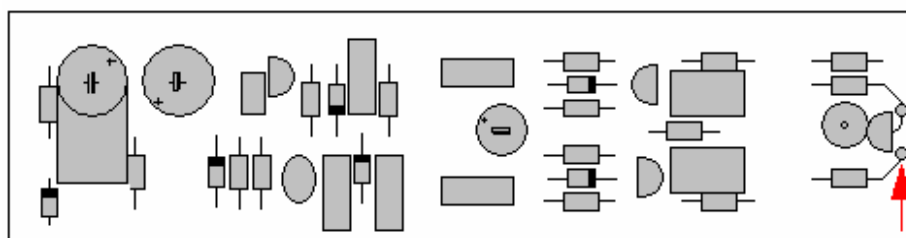

Slowly increase the level of the tone generator and observe the output signal (pin 2 or 3 on the XLR connector). Adjust the trimmer potentiometer for symmetrical clipping on both output pins.

If you have a distortion meter, you can follow the same procedure as with the oscilloscope, but you adjust the trimmer potentiometer for the lowest distortion at high input levels.

Now the time has come to connect the microphone capsule.
Connect the backplate (usually the blue or black wire) to this spot on the PCB.

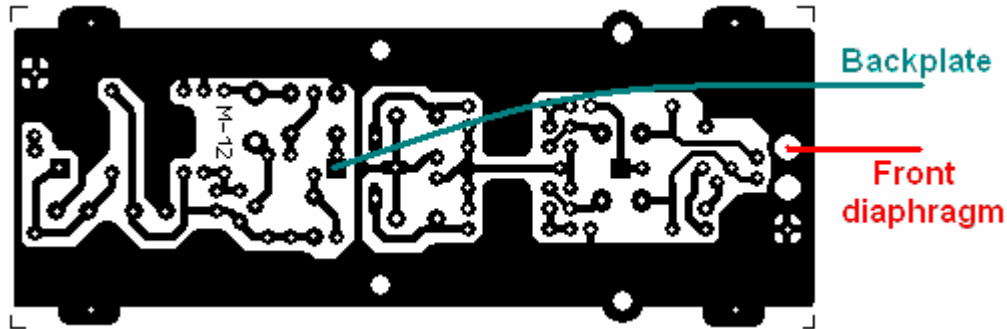

The front diaphragm is connected to the teflon feedthrough as is shown above. This works fine if you have a single sided capsule, or if you have a double sided capsule and you want to make a cardioid microphone. In this case leave the wire from the back diaphragm floating. Don't cut it off!!! Now you can always use the back diaphragm later, in case the front diaphragm becomes damaged or polluted.

If you have a double sided capsule and you want an **omni directional** microphone, connect the wires from **both** diaphragms together to the teflon feedthrough.

It is also possible to add a small (internal) switch between the wire from the back diaphragm and the teflon feedthrough. The front diaphragm stays always connected, but with the switch you can then select between cardioid and omni characteristics. Keep the wires to the switch as short as possible(!), because they will add some extra capacity that will lower the output of the microphone. Now build the PCB inside the microphone enclosure and do a final test. Put on your headphones and sing your favorite song. Does it sound good?!

The last thing you should check is the **phase** of the microphone. If you want to use the microphone together with other microphones you own, connect them both to a mixer and connect a pair of headphones. Adjust the level in such a way that both microphones have the same loudness. Check if you lose low frequencies, if you hold the microphones close together and speak into them. If so, you should reverse the wires on pin 2 and 3 of the XLR connector.

Now you have completed the RM-47 circuit and incorporated it in the microphone, we are sure that you will enjoy its quality for many years!

Pad: if you want to include a pad switch (-10 or -20 dB), you can do so by adding a capacitor to the circuit. One side of the capacitor should be connected to the input of the circuit (where the wire from the front diaphragm is connected). Keep the wire short!
The other side of the capacitor goes to one contact of the pad switch. The other contact of the pad switch is connected to the 'ground' near the input. Keep all wires short!
In this way the extra capacitor is, or is not connected in parallel with the capsule.
The value of the extra capacitor depends on the capacity of the microphone capsule and the amount of attenuation you want.
A 'normal' LDC capsule has a capacity around 80 pF.
If you want a -10 dB pad, the capacitor should be 160 pF. You can use 150 or 180 pF.
For a -20 dB pad you use 680 pF. (20 dB is a LOT!)
Keep in mind that you should use the pad switch **only at extremely high sound levels**, because you *lower* the level at the input of the amplifier circuit, while the noise of the circuit stays the same. So the signal to noise ratio will be degraded for 'normal' levels. The amplifier circuit is designed in such a way that already high sound levels can be handled without the need of a pad switch.

Transistors: Some people asked if there would be a performance benefit if they would replace the 'general purpose' BC557B transistors with 'low noise' transistors. The answer is no! To start with, the supplied BC557B transistors were tested for various parameters before they were added to the kit. We have tested several types and brands of transistors and the conclusion was that the selected BC557B transistors (made by NXP) have a noise level that can be compared with special 'low noise' types.

Troubleshooting:

Problem: No sound

Solution: It might be that you forgot the connection between the DC/DC converter and the audio part on the back of the PCB.

Problem: It is not possible to adjust the FET bias for a drain voltage of 5.25V.

Solution: If the voltage on the drain does not change when turning the cermet potentiometer, it might be that the cermet potentiometer is not inserted correctly into the PCB.

Desolder the cermet potentiometer and insert it correctly.

(All FETs are tested so that they will bias correctly in the circuit.)

Problem: Low output level and noise

Solution: Check the voltage on pin 2 and 3 on the XLR connector. (Referred to ground, pin 1 of the XLR) Voltage should be around +33/34V when powered from 48 V phantom power.

The voltages on both pins should be the same, within a couple of millivolts.

If the voltage is lower, the BC557 transistors may be inserted in the wrong position, or one(or both) transistors have become damaged.

Problem: Distortion at high(er) sound levels

Solution: Check the FET bias and adjust the drain voltage for + 5.25V.

When you are recording extremely high sound levels, you may need a 'pad'. (See the blue text above)